

# NEO PRIZM T3

## MANUAL

[www.Antec.com](http://www.Antec.com)

All rights reserved. Specifications are subject to change without prior notice. Actual products and accessories may differ from illustrations. Omissions and printing errors excepted. Content of delivery might differ in different countries or areas. Some trademarks may be claimed as the property of others.

V2.2

©1986 – 2023 Antec Inc. All rights reserved.

## 1 CONTENTS

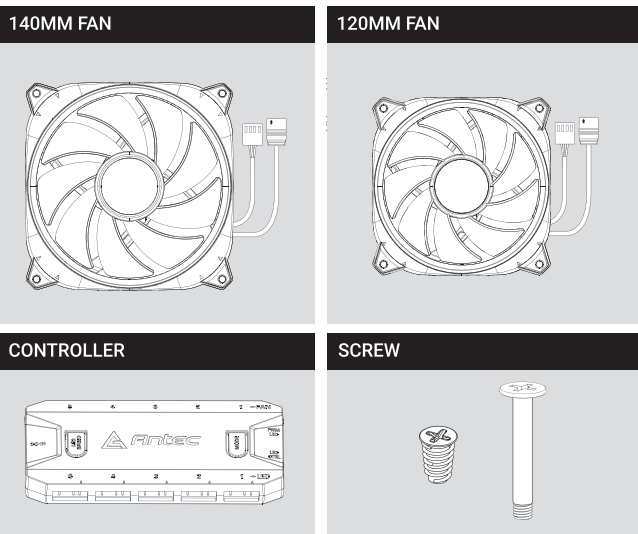

## 2 FAN INTRODUCTION

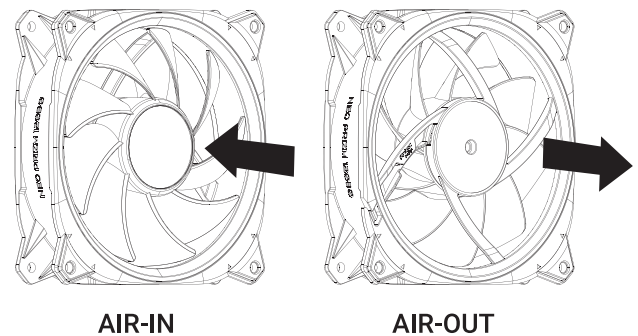

### 3 FAN INSTALLATION

#### FRONT

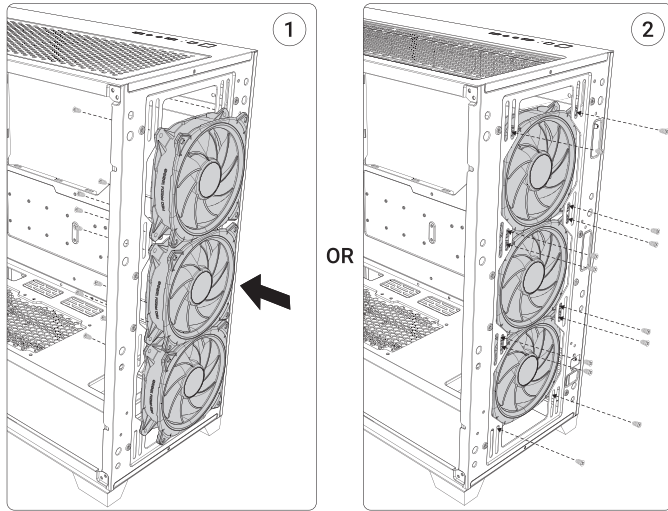

#### TOP

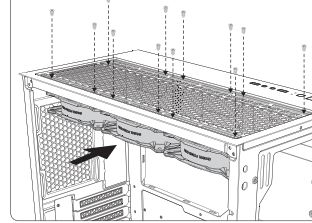

#### REAR

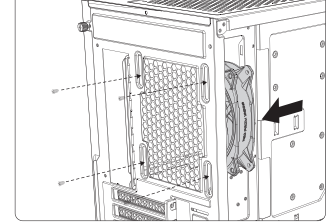

#### POWER

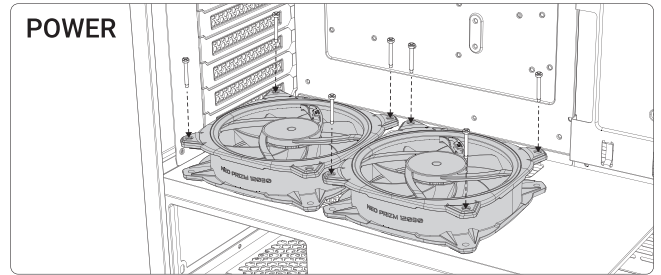

### 4 FAN CONNECTION

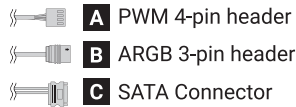

#### OPTION A :

- Connect the PWM 4-pin connector to the fan 4-pin header of the motherboard.
- Connect the ARGB 3-pin connector to the 3-pin ARGB header of the motherboard.

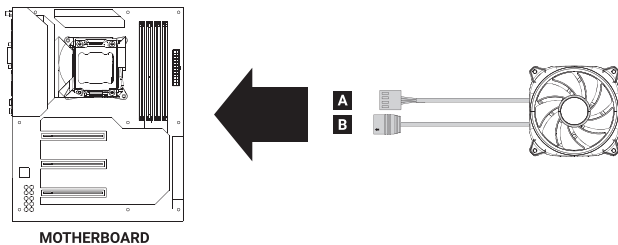

#### OPTION B :

- Connect the 4-pin PWM & 3-pin ARGB fan connector to the controller.
- Connect SATA connector of the power supply to the controller.
- Connect the controller's 4-pin PWM & 3-pin ARGB connectors to the motherboard.

