

P8 PWM PST CO

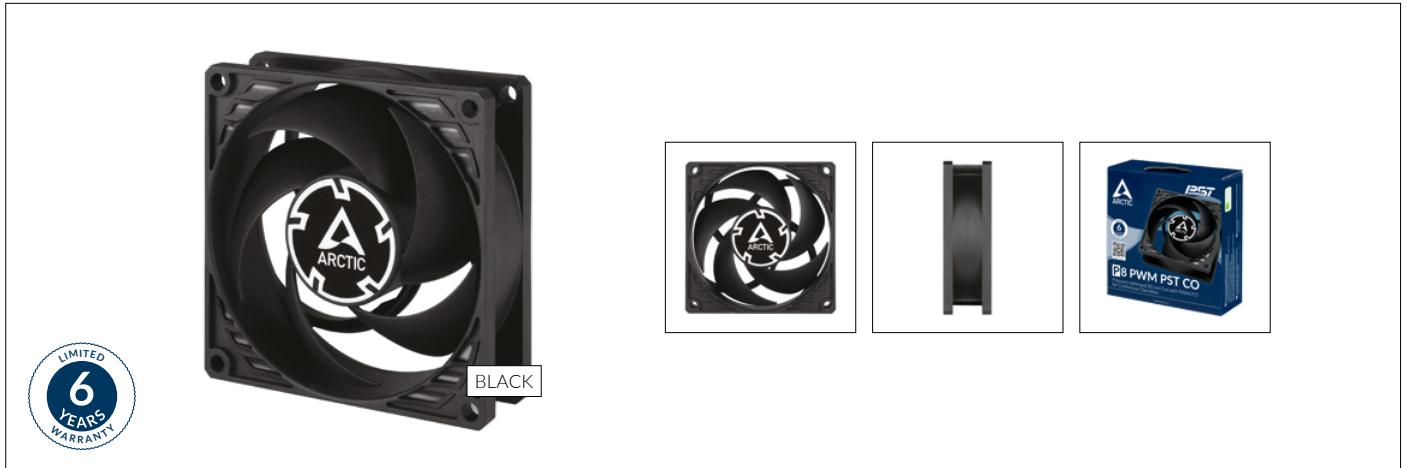

80 mm PWM with PST Case Fan for Continuous Operation



Fan Specifications

Dimensions	80 (L) x 80 (W) x 25 (H) mm
Weight	78.5 g
Speed	200-3000 rpm, 0 rpm <5% PWM
rpm Control	Pulsweitenmodulation - PWM
Static Pressure	1.9 mmH ₂ O
Airflow	23.4 cfm 39.76 m ³ /h
Bearing	Dual Ball Bearing
Cable Length	400 mm + 80 mm
Connector	4-Pin Connector + 4-Pin Socket
Current Voltage	0.09 A 12 V DC
Starting Voltage	3.4 V DC
Noise Level	0.3 Sone
Ambient Operating Temperature	0-40 °C

Shipping Information Single Fan - Black

Dimensions	82,5 (L) x 82,5 (W) x 26 (H) mm
Weight	100 g
SKU	ACFAN00151A
EAN	4895213702041
UPC	872767009936
Package Content	P8 PWM PST CO x1 Mounting Screws x4

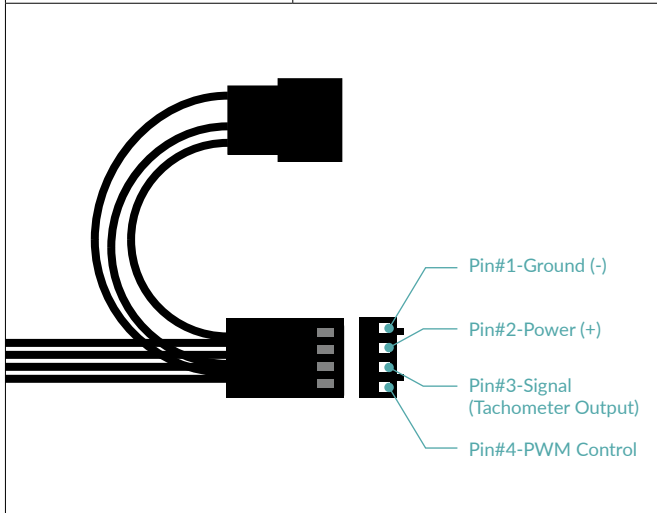

P8 PWM PST CO

80 mm PWM with PST Case Fan for Continuous Operation

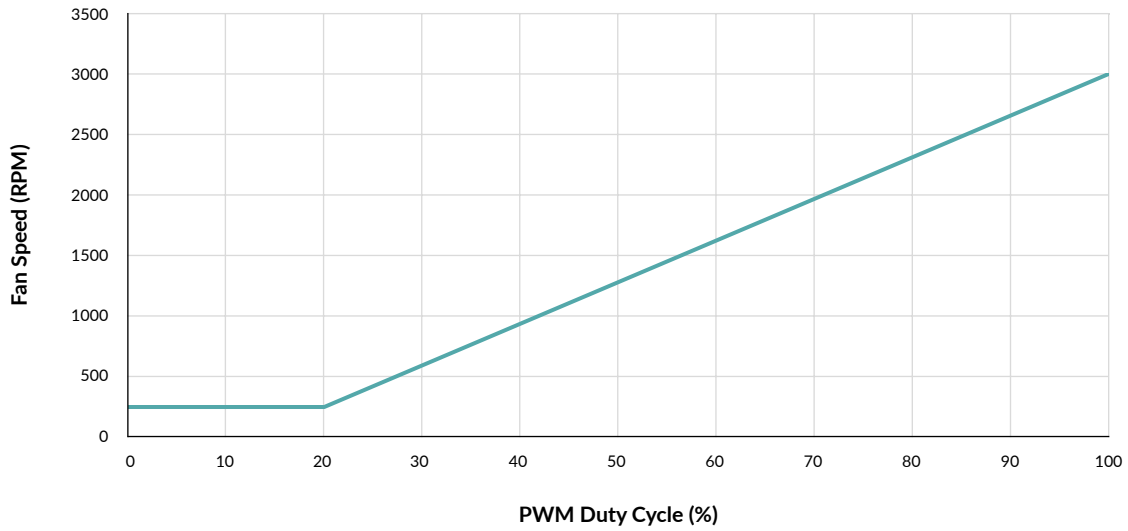
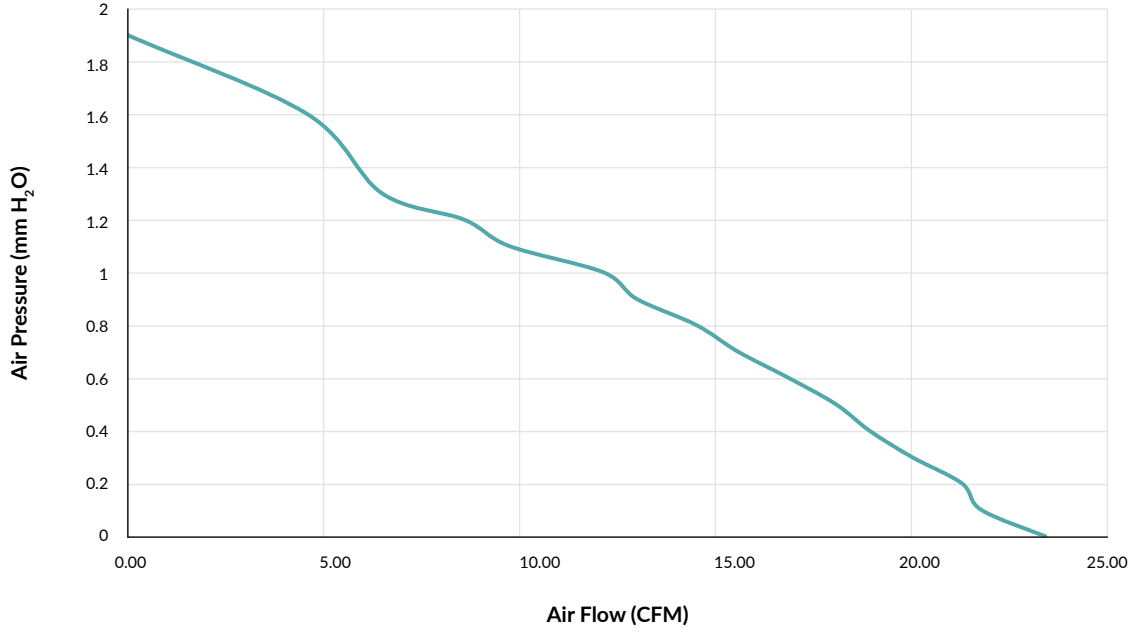

P8 PWM PST CO

80 mm PWM with PST Case Fan for Continuous Operation

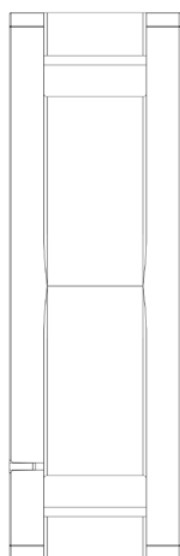
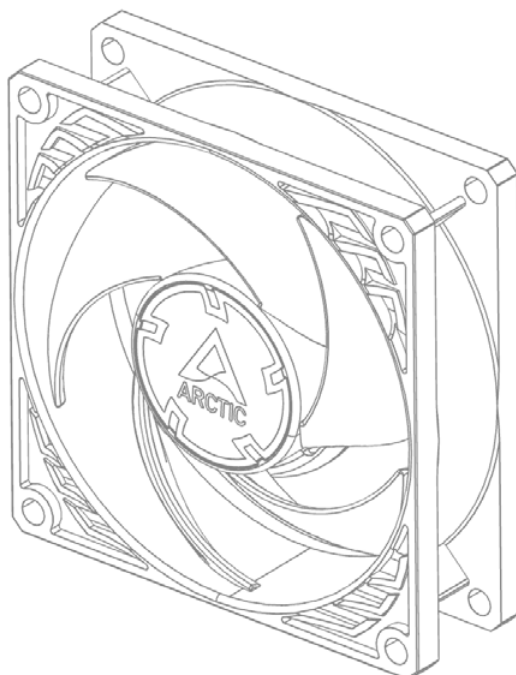

← 25 mm →

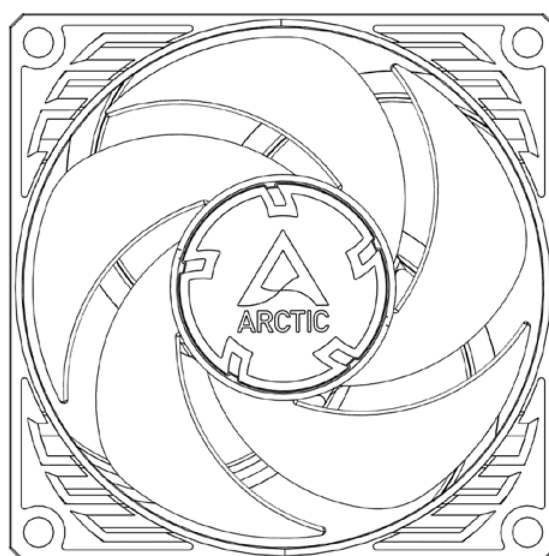

← 80 mm →

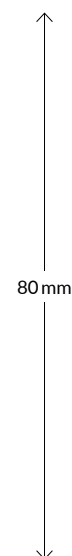

80 mm



All materials are compatible with RoHS requirements.

MORE INFORMATION



MANUALS

